

DINA SERIES

AB Type Block

46mm

46mm fixings to accompany Terminal Heads with this keycode.

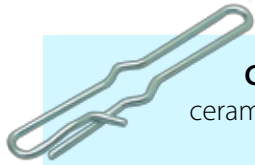
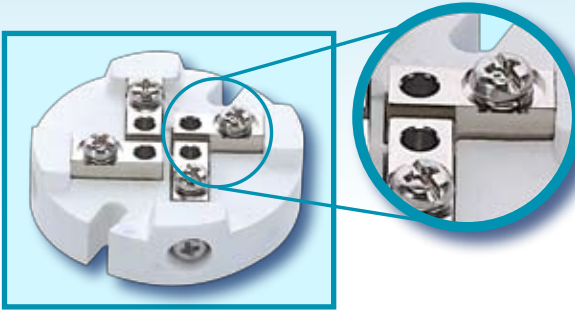

CT-CLP Clips for assembling ceramic tubes to blocks available
£0.30 €0.39

| Part No. | Poles | Material | Price Sterling | Price Euros |
|----------|-------|-----------|----------------|-------------|
| AB-2P-C | 2 | 92% Al2O3 | £2.00 | €2.60 |
| AB-4P-C | 4 | 92% Al2O3 | £2.50 | €3.25 |

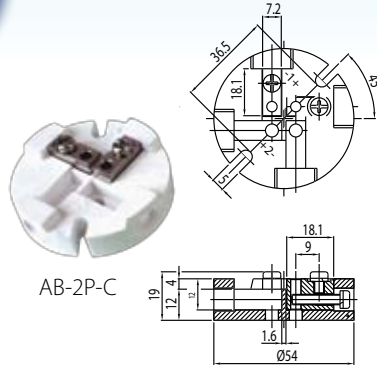

AB-2P-C

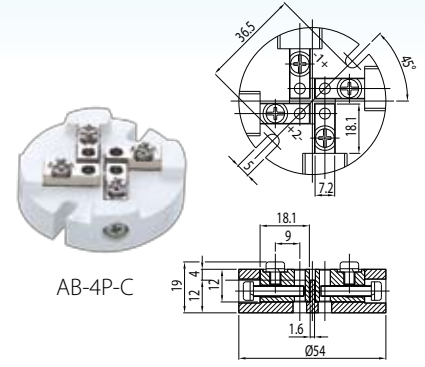

AB-4P-C

AC Type Block

46mm

46mm fixings to accompany Terminal Heads with this keycode.

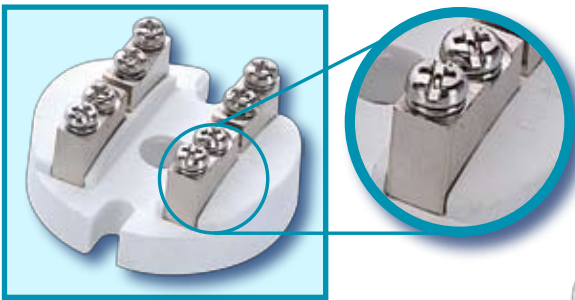

| Part No. | Poles | Material | Price Sterling | Price Euros |
|----------|-------|-----------|----------------|-------------|
| AC-2P-C | 2 | 92% Al2O3 | £1.95 | €2.54 |
| AC-4P-C | 4 | 92% Al2O3 | £2.40 | €3.12 |

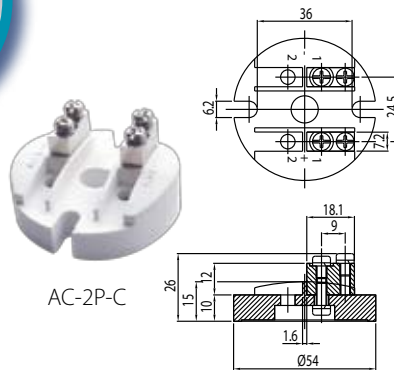

AC-2P-C

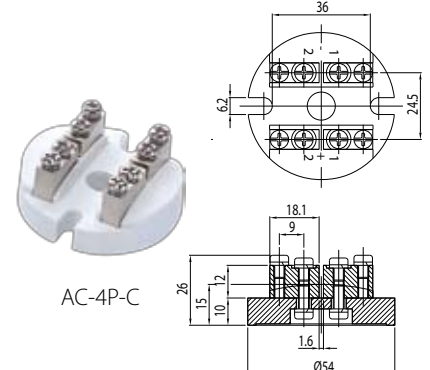

AC-4P-C

AD Type Block

46mm

46mm fixings to accompany Terminal Heads with this keycode.

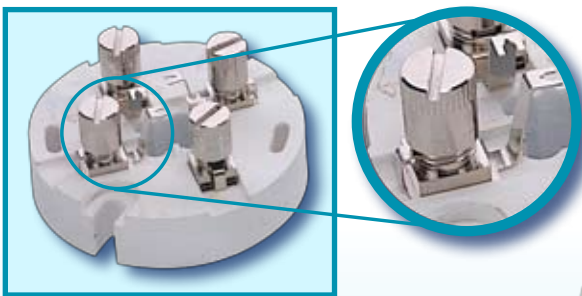

| Part No. | Poles | Material | Price Sterling | Price Euros |
|----------|-------|-----------|----------------|-------------|
| AD-2P-C | 2 | 92% Al2O3 | £1.95 | €2.54 |
| AD-4P-C | 4 | 92% Al2O3 | £2.40 | €3.12 |

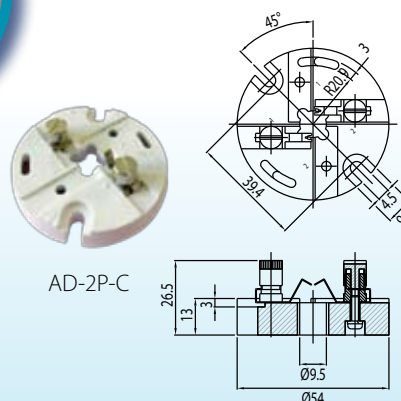

AD-2P-C

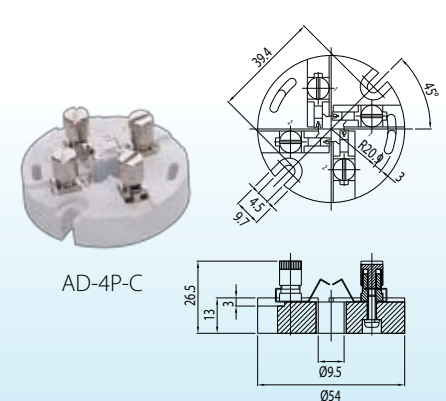

AD-4P-C

DINA SERIES

ADN Type Block

46mm

46mm fixings to accompany Terminal Heads with this keycode.

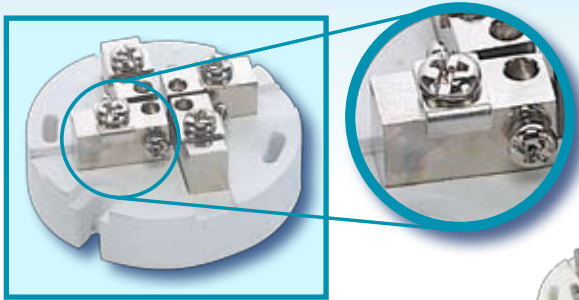

| Part No. | Poles | Material | Price Sterling | Price Euros |
|----------|-------|-----------|----------------|-------------|
| ADN-2P-C | 2 | 92% Al2O3 | £2.50 | €3.25 |
| ADN-4P-C | 4 | 92% Al2O3 | £3.15 | €4.10 |



ADN-2P-C

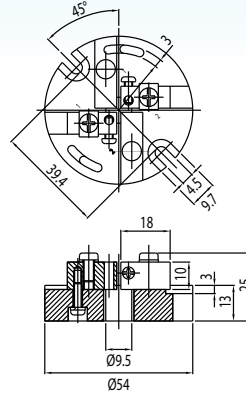

ADN-4P-C

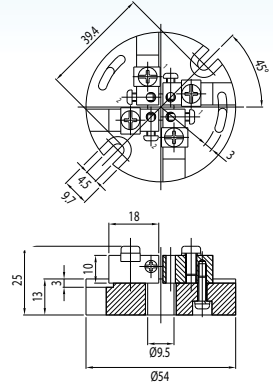

TB SERIES

TB Type Block

45mm

45mm fixings to accompany Terminal Heads with this keycode.

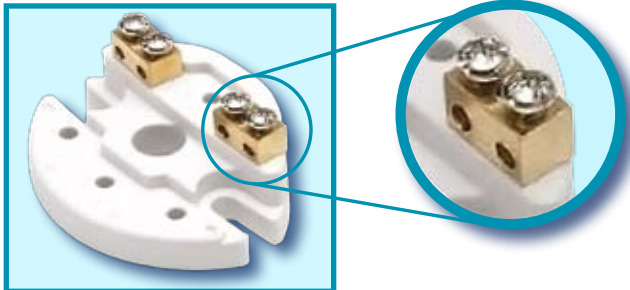

| Part No. | Poles | Material | Price Sterling | Price Euros |
|----------|-------|-----------|----------------|-------------|
| TB-2P-C | 2 | 45% Al2O3 | £1.90 | €2.47 |
| TB-3P-C | 3 | 45% Al2O3 | £2.15 | €2.80 |
| TB-4P-C | 4 | 45% Al2O3 | £2.45 | €3.19 |
| TB-6P-C | 6 | 45% Al2O3 | £3.00 | €3.90 |

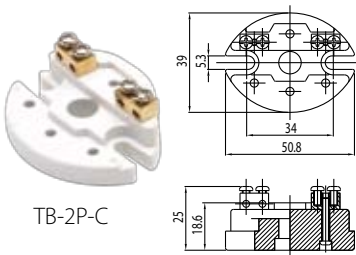

TB-2P-C

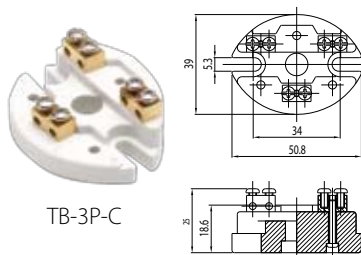

TB-3P-C

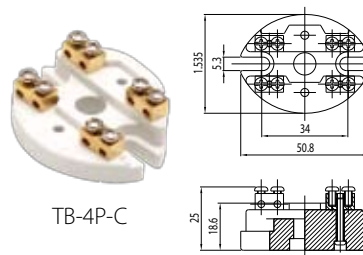

TB-4P-C

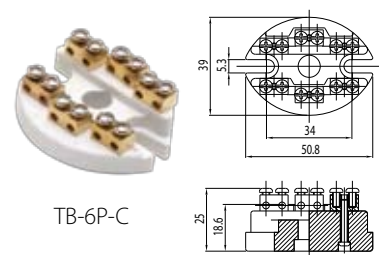

TB-6P-C

REMEMBER!

CHECK WHICH TERMINAL HEADS SUIT WHICH BLOCKS BY LOOKING AT THE COLOURED DOTS. PLEASE CONTACT OUR SALES TEAM FOR ANY ASSISTANCE.

+44 (0) 1189 730 739

SALES@TEMPERATURETECHNOLOGY.COM

WWW.TEMPERATURETECHNOLOGY.COM

| Material | CE | Price Sterling | Price Euros | |
|------------------------------------|----------|----------------|-------------|--------|
| 92% Al ₂ O ₃ | 1/2" BSF | M20 x L3 | £12.00 | €15.00 |

IP68 900-1000°C

33mm 40mm 45mm



Terminal Blocks

N SERIES

N Type Block

40mm

40mm fixings to accompany Terminal Heads with this keycode.

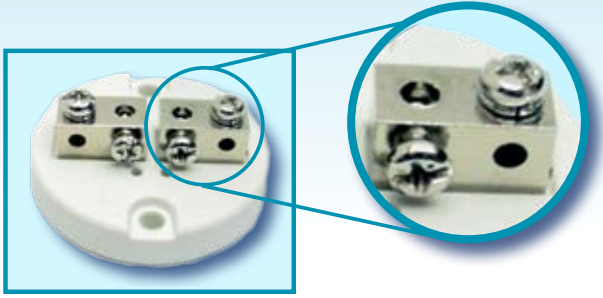

| Part No. | Poles | Material | Price Sterling | Price Euros |
|-----------|-------|-----------|----------------|-------------|
| N-2P-C | 2 | 45% Al2O3 | £1.85 | €2.41 |
| N-3P-C | 3 | 45% Al2O3 | £2.10 | €2.73 |
| N-3P-C-45 | 3 | 45% Al2O3 | £2.50 | €3.25 |
| N-4P-C | 4 | 45% Al2O3 | £2.45 | €3.19 |
| N-6P-C | 6 | 45% Al2O3 | £3.00 | €3.90 |

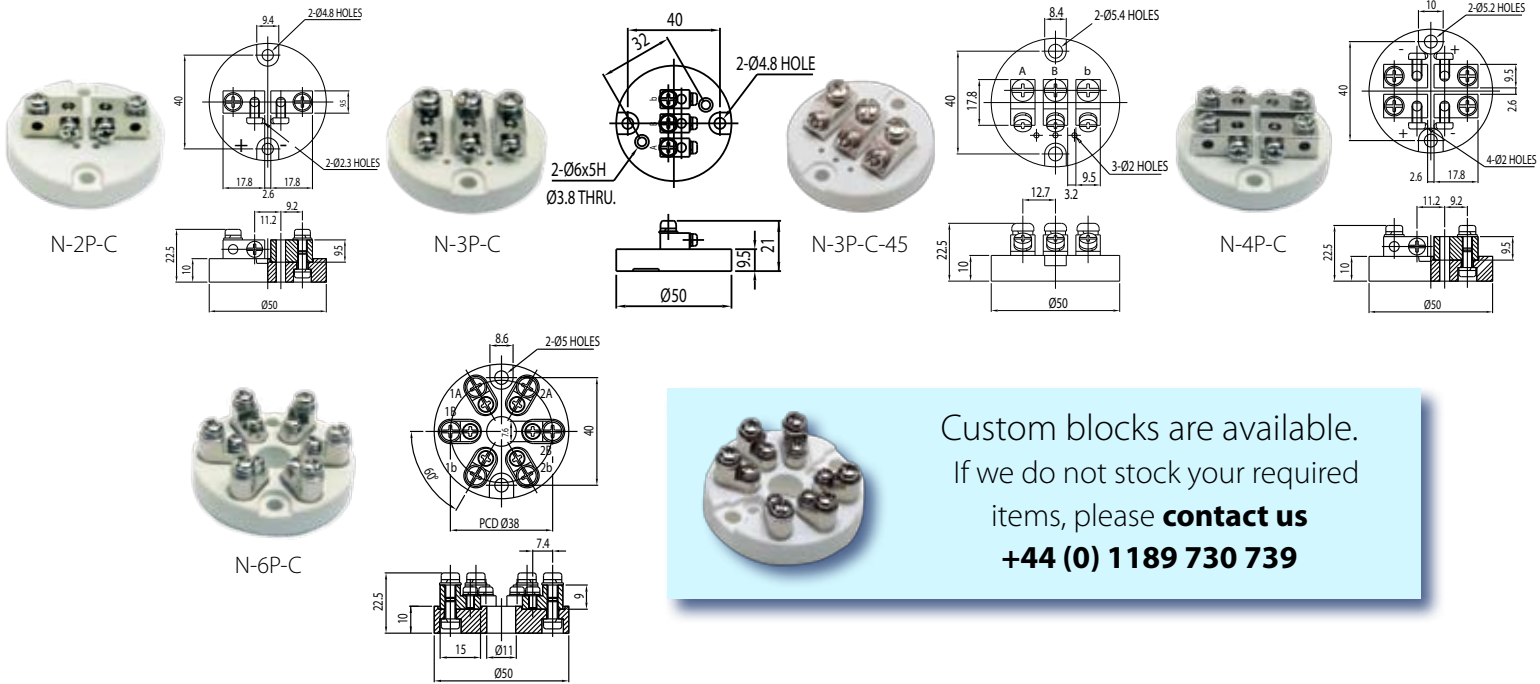

Custom blocks are available. If we do not stock your required items, please **contact us** +44 (0) 1189 730 739

N Type Block

40mm

40mm fixings to accompany Terminal Heads with this keycode.

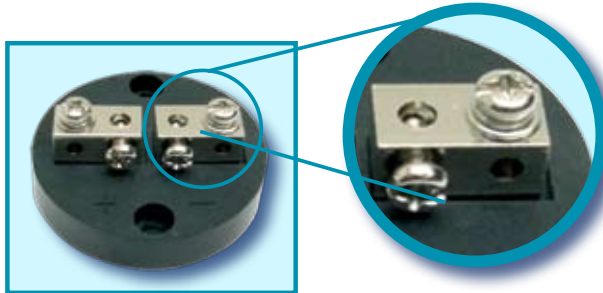

| Part No. | Poles | Material | Price Sterling | Price Euros |
|----------|-------|----------|----------------|-------------|
| N-2P-B | 2 | Bakelite | £1.85 | €2.41 |
| N-3P-B | 3 | Bakelite | £2.10 | €2.73 |
| N-4P-B | 4 | Bakelite | £2.45 | €3.19 |
| N-6P-B | 6 | Bakelite | £3.00 | €3.90 |

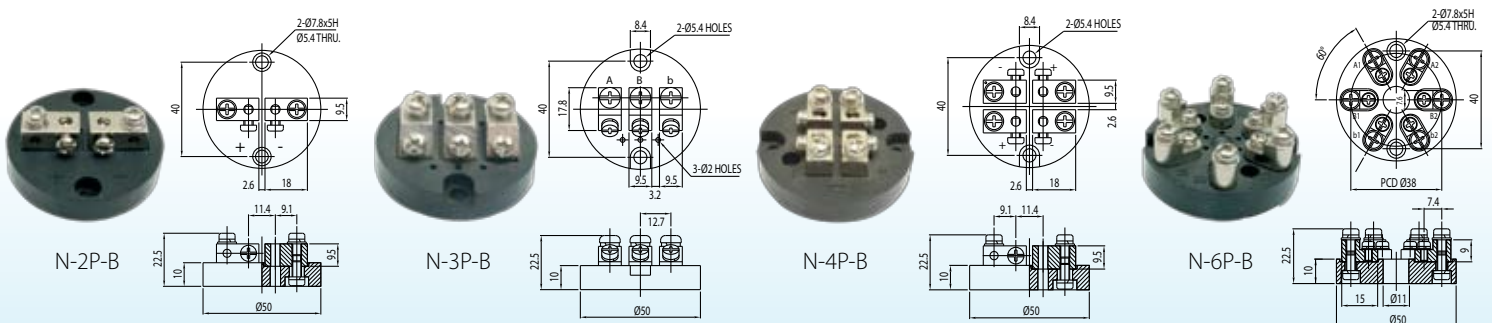

N SERIES

N-Y Type Block

40mm 40mm fixings to accompany Terminal Heads with this keycode.



| Part No. | Poles | Material | Price Sterling | Price Euros |
|-----------|-------|-----------|----------------|-------------|
| N-2P-C-Y | 2 | 45% Al203 | £1.30 | €1.69 |
| N-3P-C-Y | 3 | 45% Al203 | £1.50 | €1.95 |
| N-4P-C-Y | 4 | 45% Al203 | £1.70 | €2.21 |
| N-2P-B(H) | 2 | Bakelite | £1.30 | €1.69 |
| N-2P-B-Y | 2 | Bakelite | £1.30 | €1.69 |
| N-3P-B-Y | 3 | Bakelite | £1.50 | €1.95 |
| N-4P-B-Y | 4 | Bakelite | £1.70 | €2.21 |

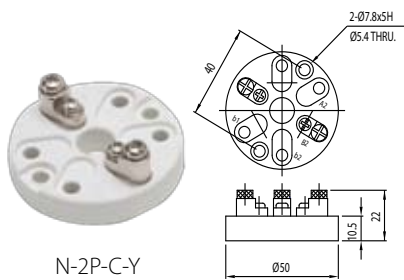

N-2P-C-Y

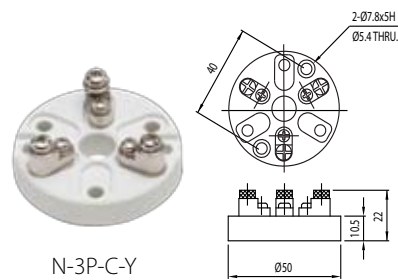

N-3P-C-Y

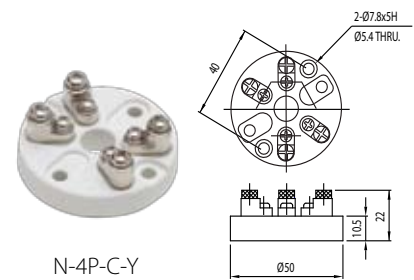

N-4P-C-Y

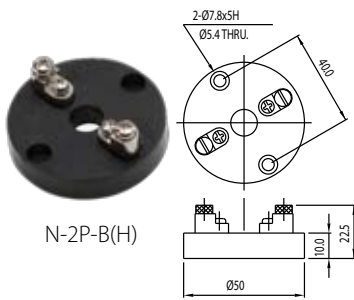

N-2P-B(H)

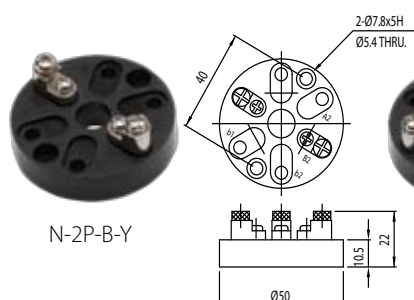

N-2P-B-Y

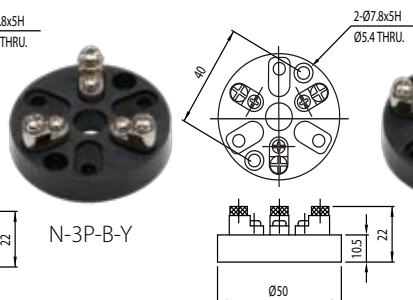

N-3P-B-Y

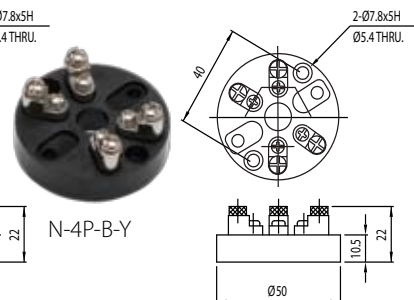

N-4P-B-Y

M SERIES

M Type Block (Screw)

33mm 33mm fixings to accompany Terminal Heads with this keycode.

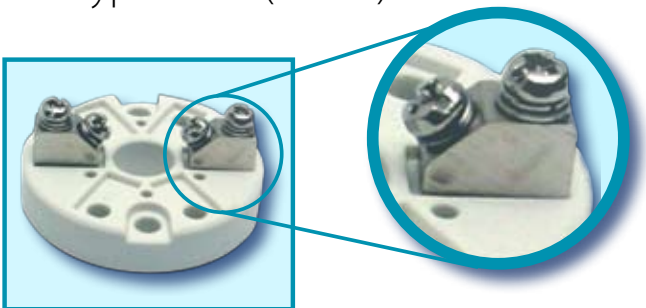

| Part No. | Poles | Material | Price Sterling | Price Euros |
|----------|-------|-----------|----------------|-------------|
| M-2P-C | 2 | 45% Al203 | £1.55 | €2.01 |
| M-3P-C | 3 | 45% Al203 | £1.75 | €2.28 |
| M-4P-C | 4 | 45% Al203 | £1.95 | €2.54 |
| M-6P-C | 6 | 45% Al203 | £2.45 | €3.19 |

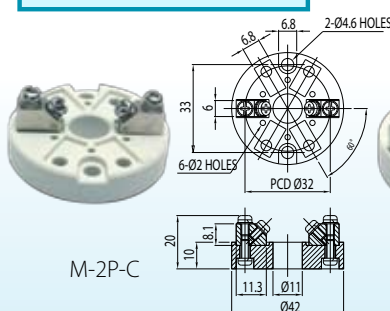

M-2P-C

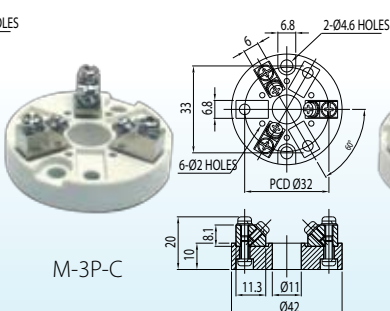

M-3P-C

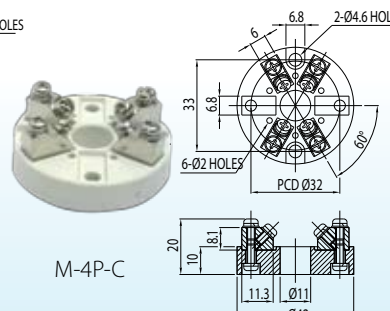

M-4P-C

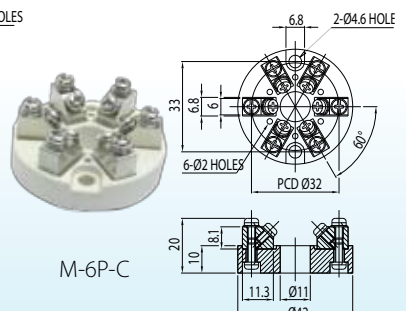

M-6P-C

Please Note: All list prices are subject to change. Check website www.temperaturetechnology.com for up to date information

M SERIES

MC Type Block (Screw with clamp)

33mm

33mm fixings to accompany Terminal Heads with this keycode.

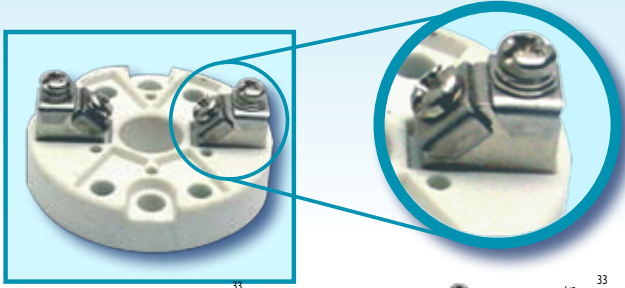

| Part No. | Poles | Material | Price Sterling | Price Euros |
|----------|-------|-----------|----------------|-------------|
| MC-2P-C | 2 | 45% Al203 | £1.50 | €1.95 |
| MC-3P-C | 3 | 45% Al203 | £1.90 | €2.47 |
| MC-4P-C | 4 | 45% Al203 | £2.25 | €2.92 |
| MC-6P-C | 6 | 45% Al203 | £3.10 | €4.03 |

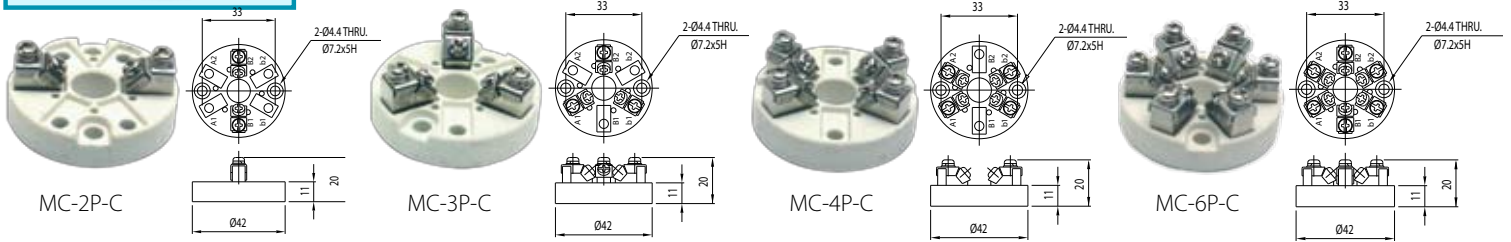

MD Type Block (Solder Lug)

33mm

33mm fixings to accompany Terminal Heads with this keycode.

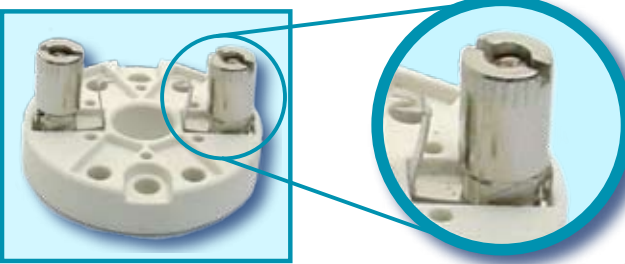

| Part No. | Poles | Material | Price Sterling | Price Euros |
|----------|-------|-----------|----------------|-------------|
| MD-2P-C | 2 | 45% Al203 | £1.55 | €2.02 |
| MD-3P-C | 3 | 45% Al203 | £1.90 | €2.48 |
| MD-4P-C | 4 | 45% Al203 | £2.30 | €2.99 |
| MD-6P-C | 6 | 45% Al203 | £3.00 | €3.90 |

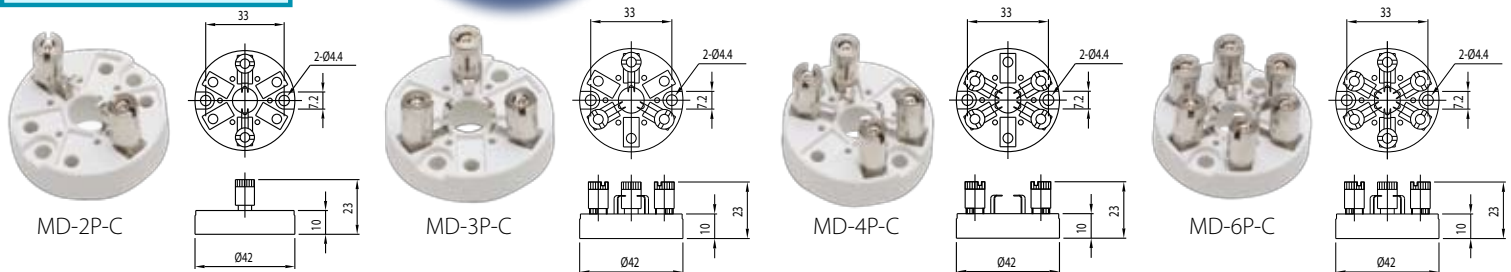

MN Type Block (No through hole)

33mm

33mm fixings to accompany Terminal Heads with this keycode.

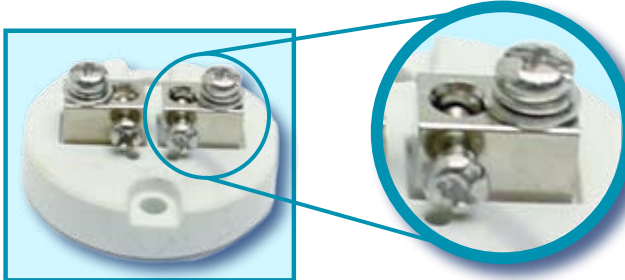

| Part No. | Poles | Material | Price Sterling | Price Euros |
|----------|-------|-----------|----------------|-------------|
| MN-2P-C | 2 | 45% Al203 | £1.85 | €2.41 |
| MN-3P-C | 3 | 45% Al203 | £2.10 | €2.73 |
| MN-4P-C | 4 | 45% Al203 | £2.45 | €3.19 |

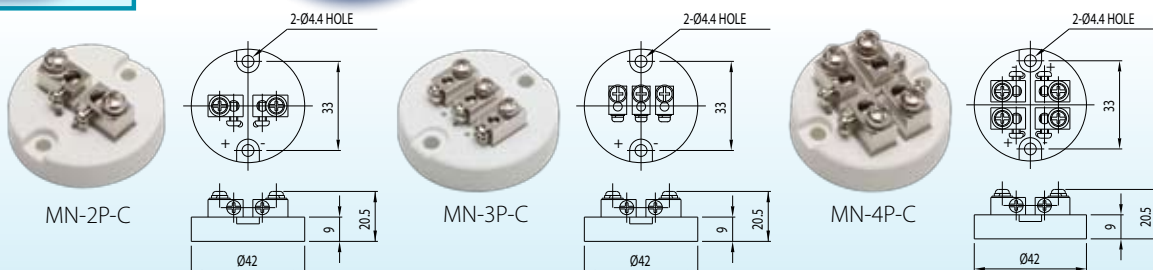

DB SERIES

DB Type Block (Solder lug)

33mm

33mm fixings to accompany Terminal Heads with this keycode.

For use with **Terminal Block Mounting Kit (p.25)**.

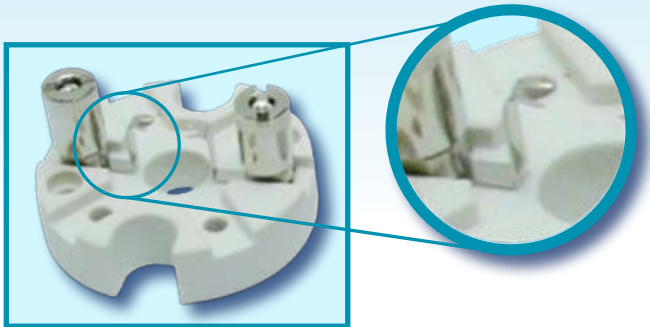

| Part No. | Poles | Material | Price Sterling | Price Euros |
|----------|-------|-----------|----------------|-------------|
| DB-2P-C | 2 | 45% Al203 | £1.75 | €2.28 |
| DB-3P-C | 3 | 45% Al203 | £1.95 | €2.54 |
| DB-4P-C | 4 | 45% Al203 | £2.15 | €2.80 |
| DB-6P-C | 6 | 45% Al203 | £2.65 | €3.45 |
| DB-8P-C | 8 | 45% Al203 | £3.65 | €4.75 |

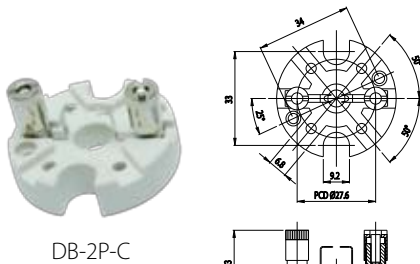

DB-2P-C



DB-3P-C

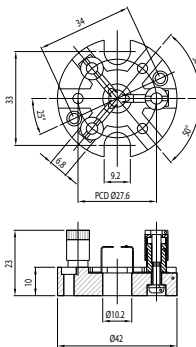

DB-4P-C

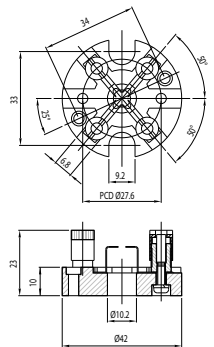

DB-6P-C

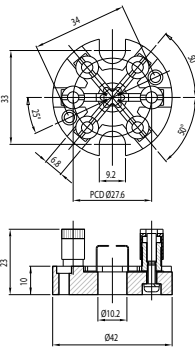

DB-8P-C

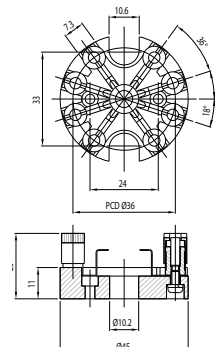

DBS Type Block (Screw)

33mm

33mm fixings to accompany Terminal Heads with this keycode.

For use with **Terminal Block Mounting Kit (p.25)**.



| Part No. | Poles | Material | Price Sterling | Price Euros |
|----------|-------|-----------|----------------|-------------|
| DBS-2P-C | 2 | 45% Al203 | £1.75 | €2.28 |
| DBS-4P-C | 4 | 45% Al203 | £2.00 | €2.60 |
| DBS-6P-C | 6 | 45% Al203 | £2.75 | €3.58 |

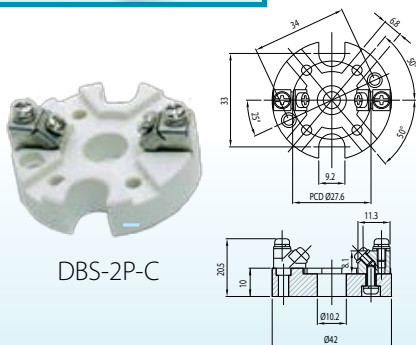

DBS-2P-C



DBS-4P-C

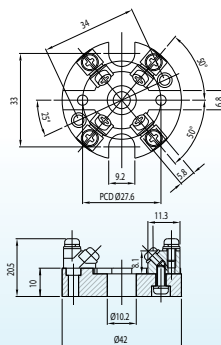

DBS-6P-C

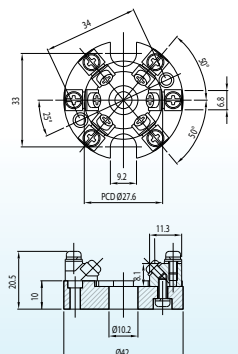

Please Note: All list prices are subject to change. Check website www.temperaturetechnology.com for up to date information

DL & DN SERIES

DL Type Block Solder Lug

33mm

33mm fixings to accompany Terminal Heads with this keycode.

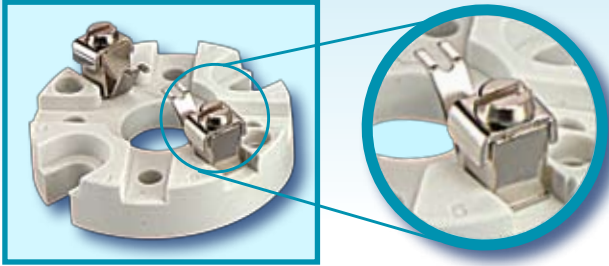

| Part No. | Poles | Material | Price Sterling | Price Euros |
|----------|-------|-----------|----------------|-------------|
| DL-2P-C | 2 | 92% Al2O3 | £2.90 | €3.77 |
| DL-3P-C | 3 | 92% Al2O3 | £3.20 | €4.16 |
| DL-4P-C | 4 | 92% Al2O3 | £3.60 | €4.68 |
| DL-6P-C | 6 | 92% Al2O3 | £4.25 | €5.53 |

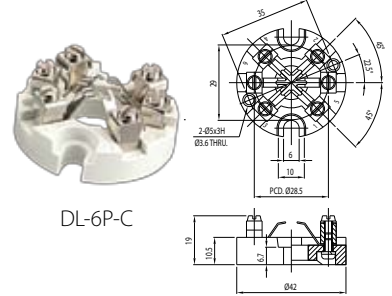
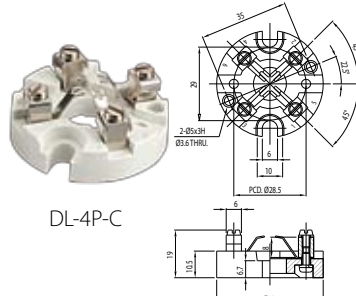
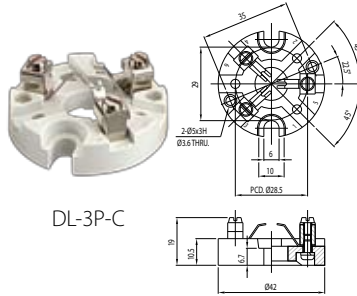
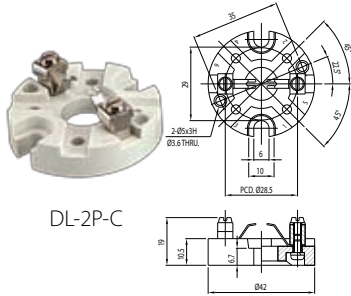

DN Type Block Screw

33mm

33mm fixings to accompany Terminal Heads with this keycode.

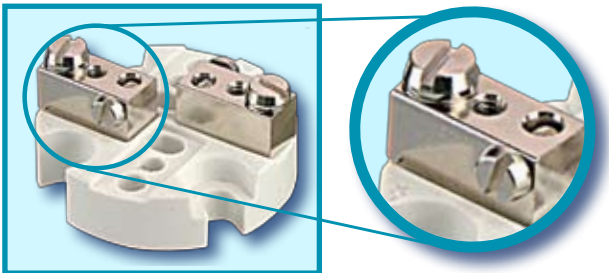

| Part No. | Poles | Material | Price Sterling | Price Euros |
|----------|-------|-----------|----------------|-------------|
| DN-2P-C | 2 | 45% Al2O3 | £2.90 | €3.77 |
| DN-4P-C | 4 | 45% Al2O3 | £3.60 | €4.68 |

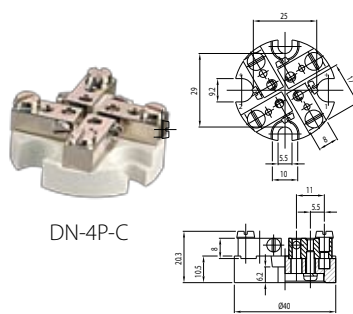
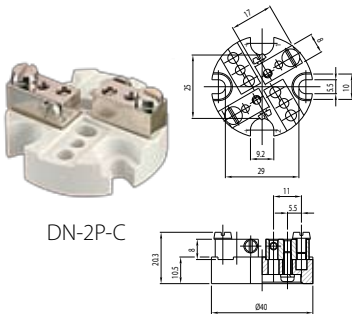

Custom blocks are available.
If we do not stock your required items, please **contact us**
+44 (0) 1189 730 739

WHAT TYPE OF SENSOR ARE YOU MAKING?

THERMOCOUPLE – normally use terminals with screws



RTD – normally use terminals with solder lugs



D SERIES

D Type Block Spring Loaded

33mm

33mm fixings to accompany Terminal Heads with this keycode. Supplied with mounting kit

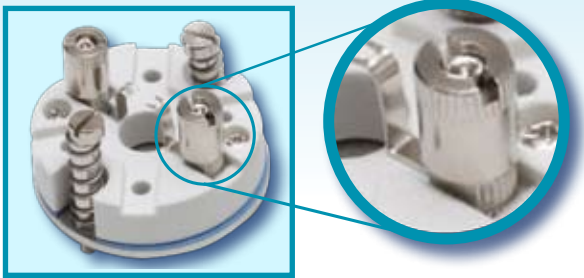

| Part No. | Poles | Material | Price Sterling | Price Euros |
|----------|-------|-----------|----------------|-------------|
| D-2P-C | 2 | 45% Al203 | £2.95 | €3.84 |
| D-3P-C | 3 | 45% Al203 | £3.15 | €4.10 |
| D-4P-C | 4 | 45% Al203 | £3.45 | €4.49 |
| D-6P-C | 6 | 45% Al203 | £3.95 | €5.14 |
| D-8P-C | 8 | 45% Al203 | £5.75 | €7.48 |

N.B. Supplied unassembled as standard – assembled on request

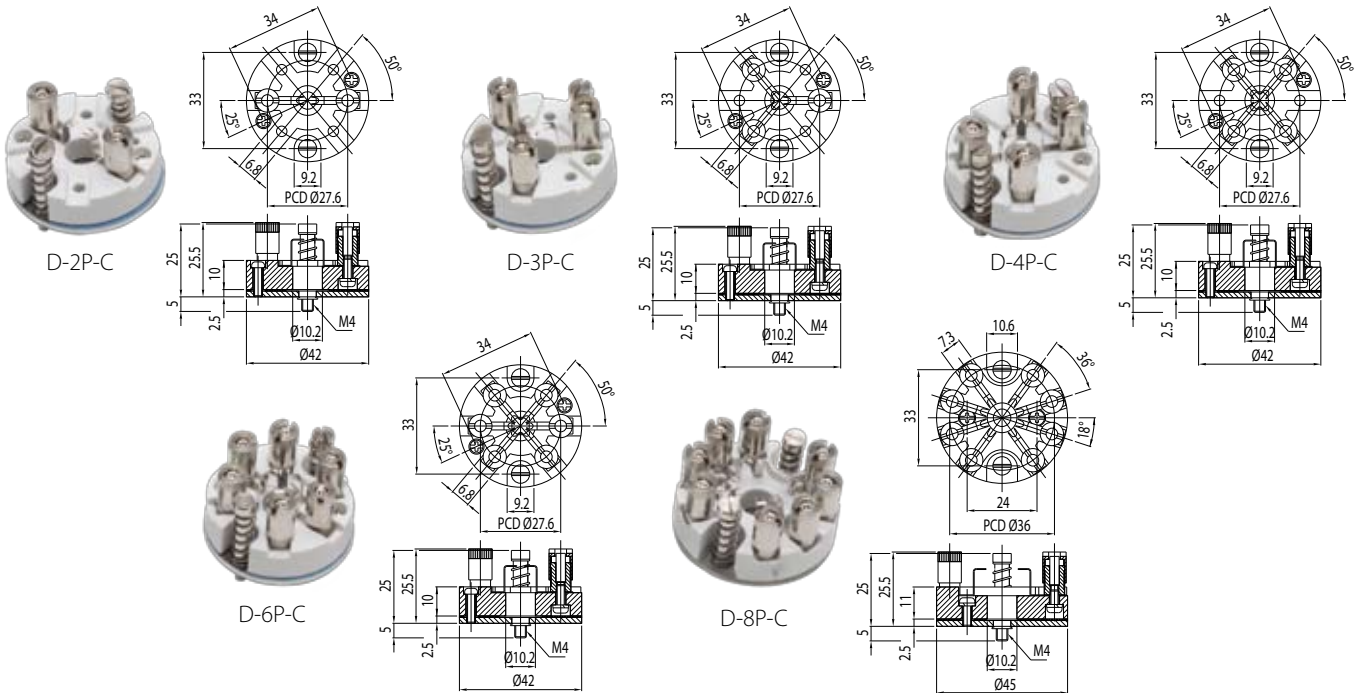

D Type Block Spring Loaded

33mm

33mm fixings to accompany Terminal Heads with this keycode. Supplied with mounting kit

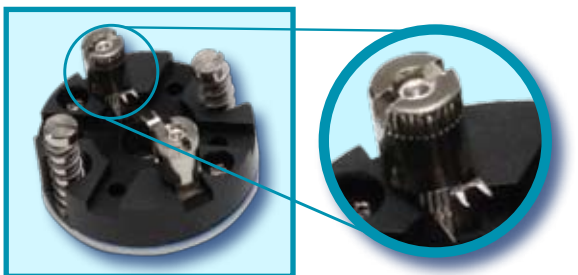

| Part No. | Poles | Material | Price Sterling | Price Euros |
|----------|-------|----------|----------------|-------------|
| D-2P-B | 2 | Bakelite | £2.95 | €3.84 |
| D-3P-B | 3 | Bakelite | £3.15 | €4.10 |
| D-4P-B | 4 | Bakelite | £3.45 | €4.49 |
| D-6P-B | 6 | Bakelite | £3.95 | €5.14 |

N.B. Supplied unassembled as standard – assembled on request

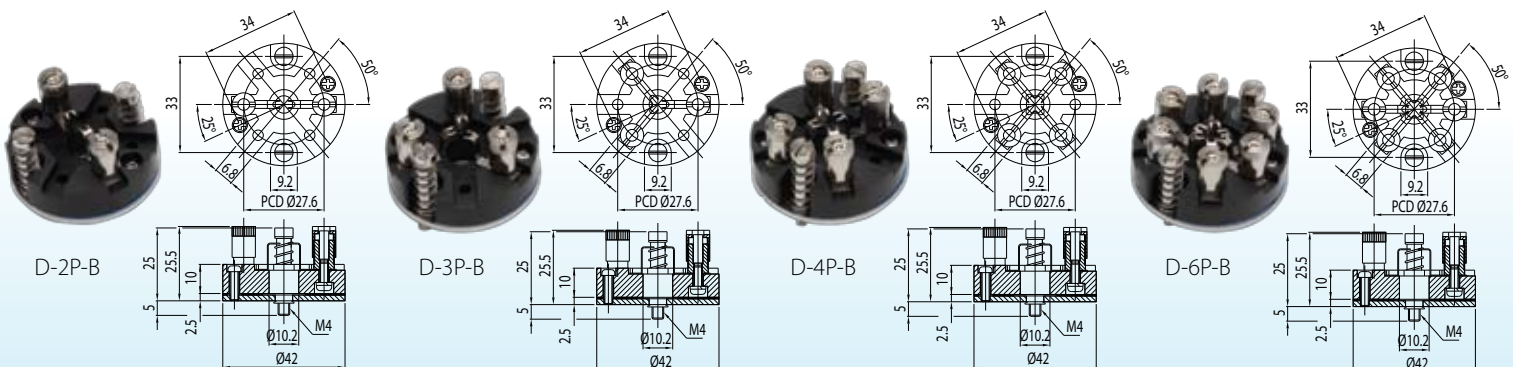

DS SERIES

DS Type Block Spring Loaded

33mm

33mm fixings to accompany Terminal Heads with this keycode.

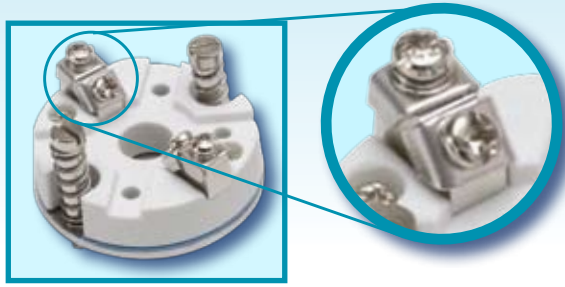

| Part No. | Poles | Material | Price Sterling | Price Euros |
|----------|-------|-----------|----------------|-------------|
| DS-2P-C | 2 | 45% Al203 | £3.00 | €3.90 |
| DS-3P-C | 3 | 45% Al203 | £3.15 | €4.10 |
| DS-4P-C | 4 | 45% Al203 | £3.60 | €4.68 |
| DS-6P-C | 6 | 45% Al203 | £4.25 | €5.53 |

N.B. DS-Series blocks are supplied unassembled.

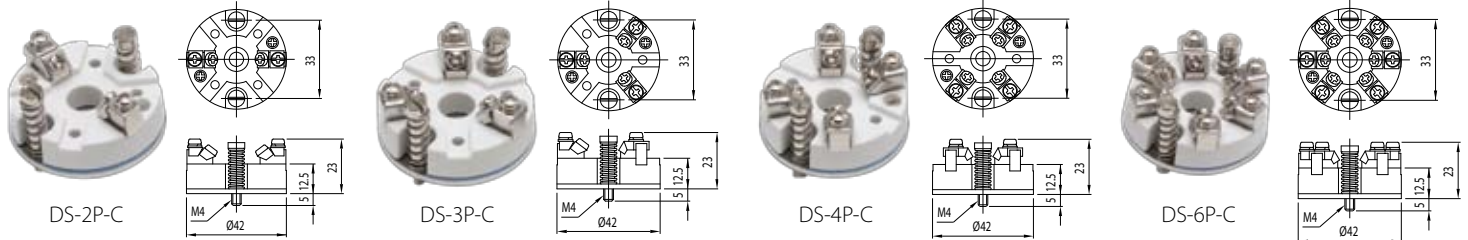

DS Type Block Spring Loaded

33mm

33mm fixings to accompany Terminal Heads with this keycode.

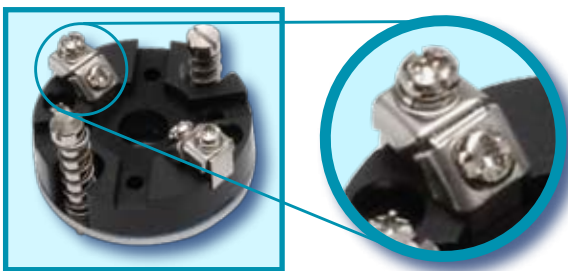

| Part No. | Poles | Material | Price Sterling | Price Euros |
|----------|-------|----------|----------------|-------------|
| DS-2P-B | 2 | Bakelite | £3.00 | €3.90 |
| DS-3P-B | 3 | Bakelite | £3.15 | €4.10 |
| DS-4P-B | 4 | Bakelite | £3.60 | €4.68 |
| DS-6P-B | 6 | Bakelite | £4.25 | €5.53 |

N.B. DS-Series blocks are supplied unassembled.

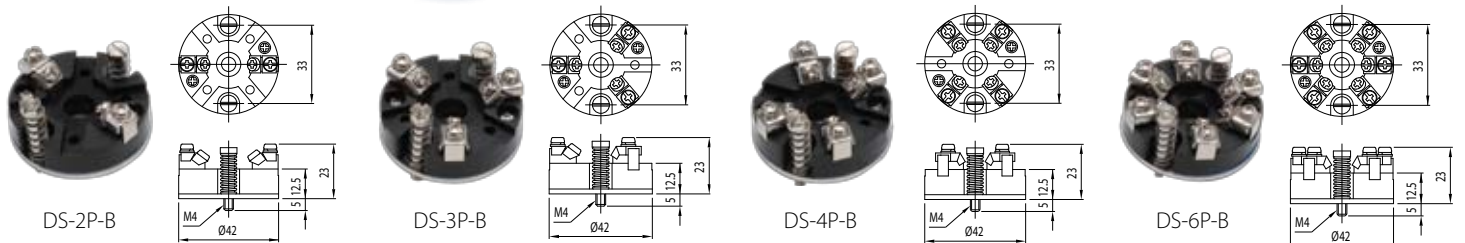

S SERIES

S Type Block

27mm

27mm fixings to accompany Terminal Heads with this keycode.

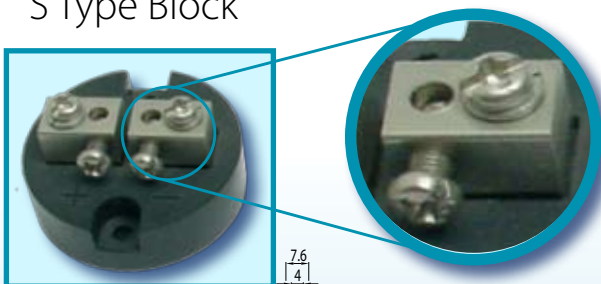

| Part No. | Poles | Material | Price Sterling | Price Euros |
|-----------|-------|----------|----------------|-------------|
| S-2P-B | 2 | Bakelite | £1.30 | €1.69 |
| S-3P-B | 3 | Bakelite | £1.50 | €1.95 |
| S-3P-B-45 | 3 | Bakelite | £1.85 | €2.41 |
| S-4P-B | 4 | Bakelite | £1.85 | €2.41 |

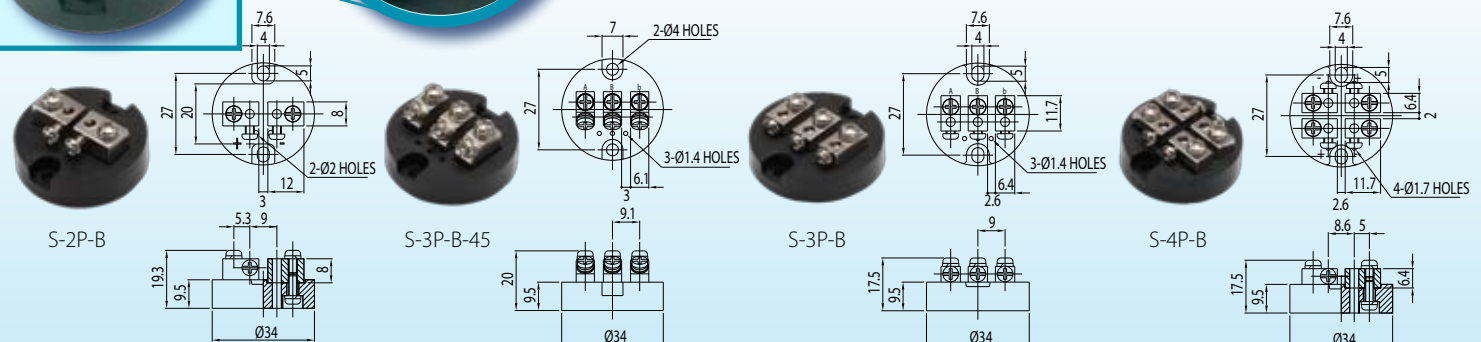

S SERIES

S Type Block

27mm 27mm fixings to accompany Terminal Heads with this keycode.

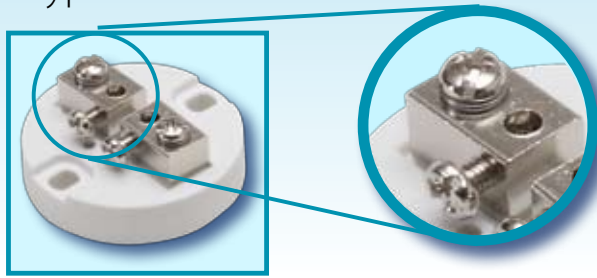

| Part No. | Poles | Material | Price Sterling | Price Euros |
|-----------|-------|-----------|----------------|-------------|
| S-2P-C | 2 | 45% Al203 | £1.30 | €1.69 |
| S-3P-C | 3 | 45% Al203 | £1.50 | €1.95 |
| S-3P-C-45 | 3 | 45% Al203 | £1.85 | €2.41 |
| S-4P-C | 4 | 45% Al203 | £1.85 | €2.41 |

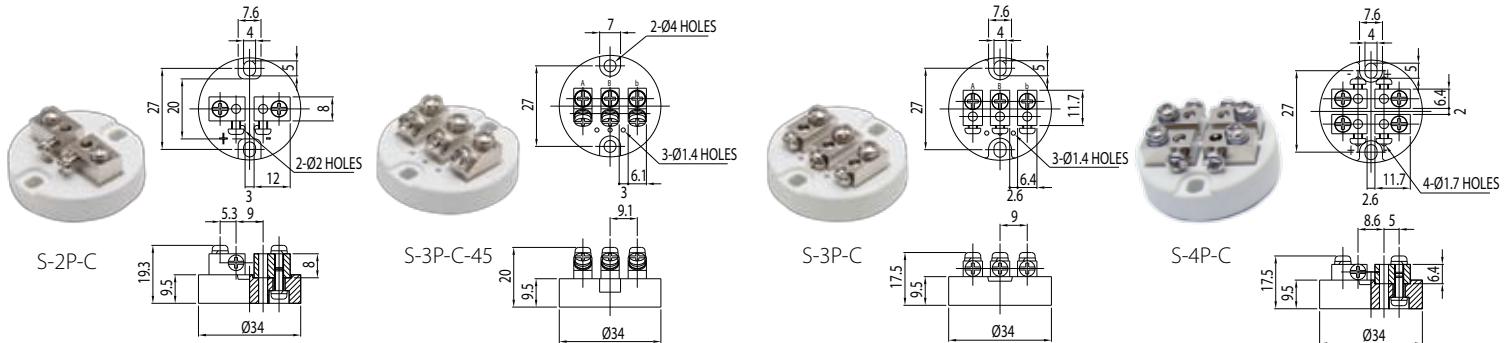

MA SERIES

MA Type Block

20mm 20mm fixings to accompany Terminal Heads with this keycode.

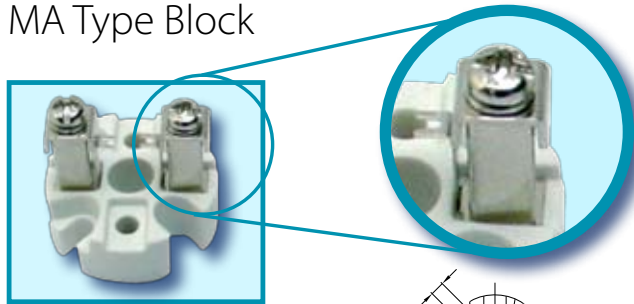

| Part No. | Poles | Material | Price Sterling | Price Euros |
|----------|-------|-----------|----------------|-------------|
| MA-2P-C | 2 | 45% Al203 | £1.35 | €1.76 |
| MA-3P-C | 3 | 45% Al203 | £1.60 | €2.08 |
| MA-4P-C | 4 | 45% Al203 | £1.80 | €2.34 |

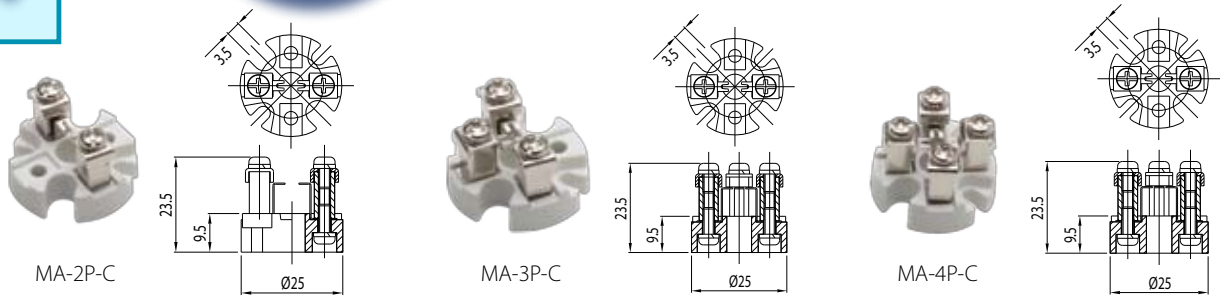

A SERIES

A Type Block

19mm 19mm fixings to accompany Terminal Heads with this keycode.

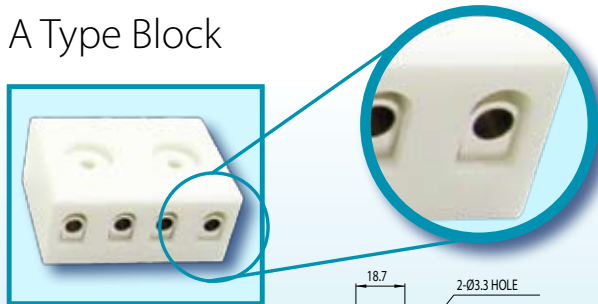

| Part No. | Poles | Material | Price Sterling | Price Euros |
|----------|-------|-----------|----------------|-------------|
| A-2P-C | 2 | 45% Al203 | £1.50 | €1.95 |
| A-3P-C | 3 | 45% Al203 | £1.75 | €2.28 |
| A-4P-C | 4 | 45% Al203 | £2.10 | €2.73 |

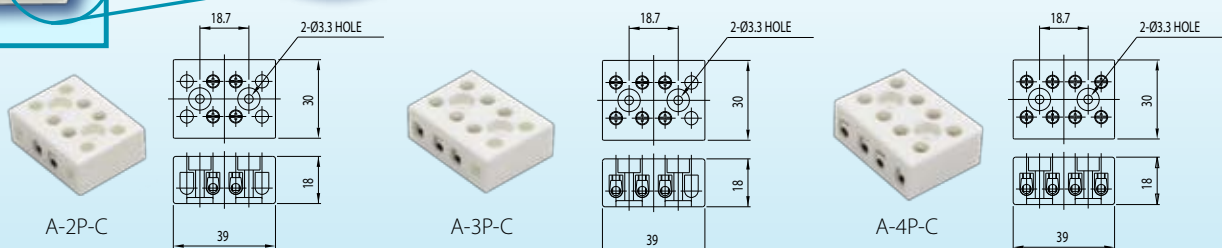

ACCESSORIES

Terminals Posts (included with DB blocks)

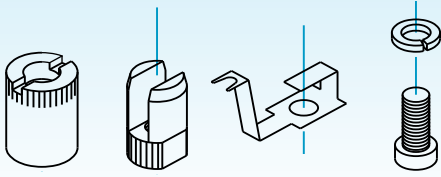

| Part No. | Description | Price Sterling | Price Euros |
|----------|---------------|----------------|-------------|
| TP | Terminal Post | £0.60 | €0.78 |

Mounting Kits



Mounting Kit MK-P.



Mounting Kit MK-6 (6mm dia x 10mm support tube).

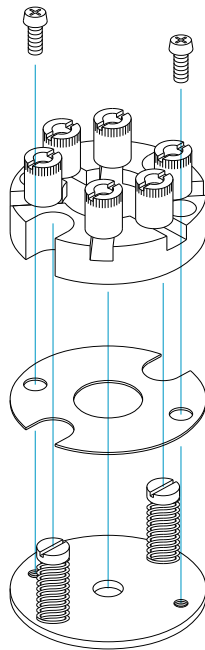

| Part No. | Description | Price Sterling | Price Euros |
|----------|---------------------------|----------------|-------------|
| MK-P | Mounting Kit | £1.60 | €2.08 |
| MK-6 | Mounting Kit support tube | £2.25 | €2.93 |

Block
(supplied separately)

Gasket*

Screws & Springs*

Din Plate*

***included in mounting kit.**

Please Note

Discounts can be given off all list prices dependent upon quantity.

All list prices are subject to change. Check website for up to date information www.temperaturetechnology.com.

Gaskets EPDM Material



| Part No. | Description | Price Sterling | Price Euros |
|----------|-------------------------------------|----------------|-------------|
| DG | Gasket for D Series Terminal Block | £0.35 | €0.46 |
| MA-G | Gasket for MA Series Terminal Block | £0.30 | €0.39 |

Din Plates



| Part No. | Description | Price Sterling | Price Euros |
|----------|-----------------------------|----------------|-------------|
| DPT | DIN plate with 6mm bore | £0.90 | €1.17 |
| DPT8 | DIN plate with support tube | £1.25 | €1.63 |