

STANDARD RANGE - PLUGS/MALE

COMPATIBILITY

TTL offer 2 ranges of connectors. Please check colour codes for compatibility.

Thermo = Standard solid pin

Thermo = Miniature flat pin

TTL = Standard hollow pin

TTL = Miniature flat pin

PLEASE NOTE - Our TTL connector range offers you a low-cost, high quality alternative:

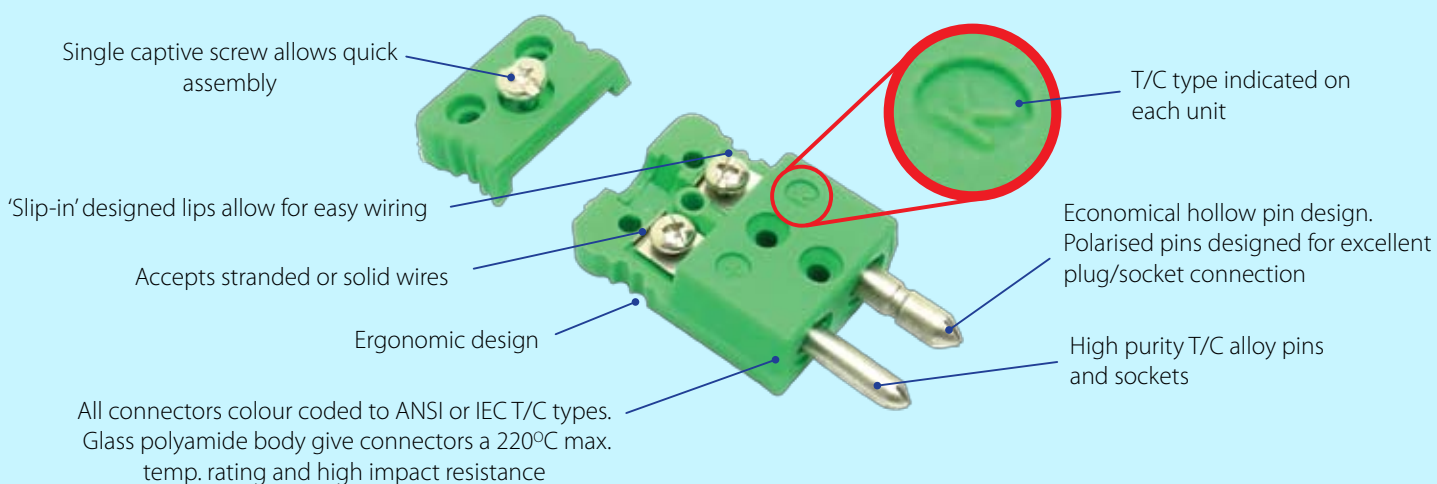

Standard Solid Pin Plug

200°C continuous use.

Thermo

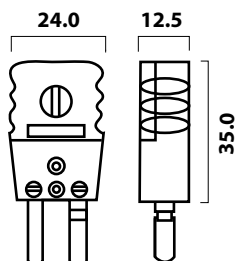

Part No.	T/C	ANSI	IEC	Colour	Price Sterling	Price Euro
S-020-SKI	K		●	Green	£2.30	€2.99
S-020-SKA	K	●		Yellow	£2.30	€2.99
S-020-SJI	J	●	●	Black	£2.30	€2.99
S-020-STI	T		●	Brown	£2.30	€2.99
S-020-STA	T	●		Blue	£2.30	€2.99
S-020-SB	B	●	●	Grey	£2.30	€2.99
S-020-SNI	N		●	Pink	£2.30	€2.99
S-020-SCU	Cu	●	●	White	£2.30	€2.99
S-020-SRI	R		●	Orange	£2.30	€2.99
S-020-SRA	R	●		Green	£2.30	€2.99

High Temperature Standard Solid Pin Plug

350°C continuous use.

Thermo

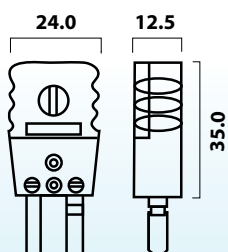

Part No.	T/C	ANSI	IEC	Colour	Price Sterling	Price Euro
S-025-SKI	K		●	Green	£4.10	€5.33
S-025-SKA	K	●		Yellow	£4.10	€5.33
S-025-SNI	N		●	Pink	£4.10	€5.33
S-025-SCU	Cu	●	●	White	£4.10	€5.33
S-025-SRI	R		●	Orange	£4.10	€5.33

Please Note: All list prices are subject to change. Check website www.temperaturetechnology.com for up to date information

STANDARD RANGE - PLUGS/MALE

Standard Hollow Pin Plug

220°C continuous use.

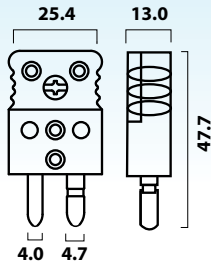

Part No.	T/C	ANSI	IEC	Colour	Price Sterling	Price Euros
S-KPI-HP	K		●	Green	£2.00	€2.60
S-KPA-HP	K	●		Yellow	£2.00	€2.60
S-JP-HP	J	●	●	Black	£2.00	€2.60
S-TPI-HP	T		●	Brown	£2.00	€2.60
S-TPA-HP	T	●		Blue	£2.00	€2.60
S-NPI-HP	N		●	Pink	£2.00	€2.60
S-NPA-HP	N	●		Orange	£2.00	€2.60

Standard Solid 3 Pin Thermocouple Plug

200°C continuous use.

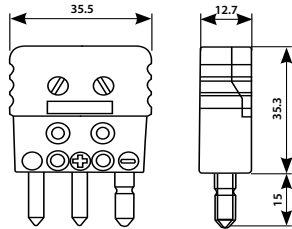

Part No.	T/C	ANSI	IEC	Colour	Price Sterling	Price Euro
S-023-SKI	K		●	Green	£6.00	€7.80
S-023-SKA	K	●		Yellow	£6.00	€7.80

Standard Hollow 3 Pin RTD Plug

220°C continuous use.

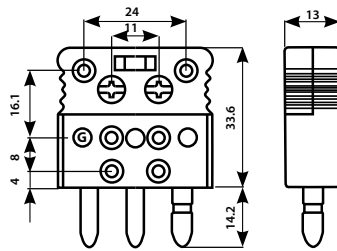

Part No.	Type	Colour	Price Sterling	Price Euro
S-RTD-P	RTD	White	£3.00	€3.90

Check out our website for latest prices & regular updates:
www.temperaturetechnology.com

Ceramic Hollow Pin Plug

500°C continuous use.

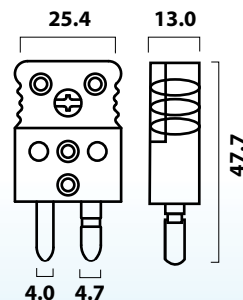

Part No.	T/C	ANSI	IEC	Colour	Price Sterling	Price Euro
S-KPI-C-HP	K		●	Green	£5.50	€7.15
S-KPA-C-HP	K	●		Yellow	£5.50	€7.15
S-NPI-C-HP	N		●	Pink	£5.50	€7.15
S-NPA-C-HP	N	●		Orange	£5.50	€7.15

CONTACT OUR SALES TEAM: Tel: +44(0)118 9730739 Fax: +44(0)118 9737222
 info@temperaturetechnology.com

STANDARD RANGE - PLUGS/MALE

Standard Solid Pin Duplex Plug

200°C continuous use.

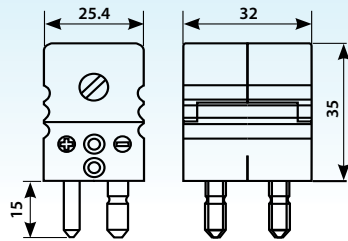

Part No.	T/C	ANSI	IEC	Colour	Price Sterling	Price Euro
421-II-21	K		●	Green	£16.50	€21.45

STANDARD RANGE - SOCKETS/FEMALE

Standard Socket

200°C continuous use.

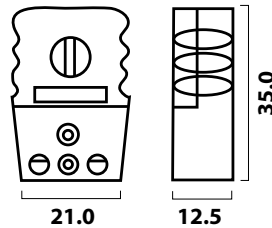

Thermo

Part No.	T/C	ANSI	IEC	Colour	Price Sterling	Price Euro
S-020-KKI	K		●	Green	£2.30	€2.99
S-020-KKA	K	●		Yellow	£2.30	€2.99
S-020-KJI	J	●	●	Black	£2.30	€2.99
S-020-KTI	T		●	Brown	£2.30	€2.99
S-020-KTA	T	●		Blue	£2.30	€2.99
S-020-KB	B	●	●	Grey	£2.30	€2.99
S-020-KNI	N		●	Pink	£2.30	€2.99
S-020-KCU	Cu	●	●	White	£2.30	€2.99
S-020-KRI	R		●	Orange	£2.30	€2.99

High Temperature Standard Socket

350°C continuous use.

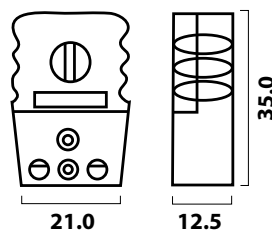

Thermo

Part No.	T/C	ANSI	IEC	Colour	Price Sterling	Price Euro
S-025-KKI	K		●	Green	£4.10	€5.33
S-025-KKA	K	●		Yellow	£4.10	€5.33
S-025-KNI	N		●	Pink	£4.10	€5.33
S-025-KCU	Cu	●	●	White	£4.10	€5.33
S-025-KRI	R		●	Orange	£4.10	€5.33

Standard Socket

220°C continuous use.

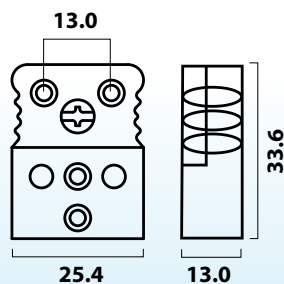

TTL

Part No.	T/C	ANSI	IEC	Colour	Price Sterling	Price Euros
S-KSI	K		●	Green	£2.00	€2.60
S-KSA	K	●		Yellow	£2.00	€2.60
S-JS	J	●	●	Black	£2.00	€2.60
S-TSI	T		●	Brown	£2.00	€2.60
S-TSA	T	●		Blue	£2.00	€2.60
S-NSI	N		●	Pink	£2.00	€2.60
S-NSA	N	●		Orange	£2.00	€2.60

STANDARD RANGE - SOCKETS/FEMALE

Standard Solid 3 Pin Thermocouple Socket

200°C continuous use.

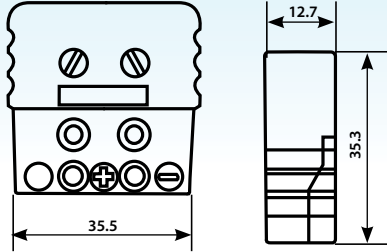
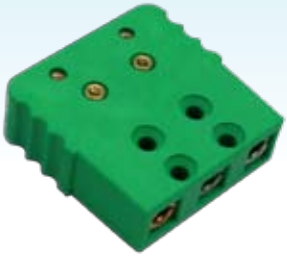

Part No.	T/C	ANSI	IEC	Colour	Price Sterling	Price Euro
S-023-KKI	K		●	Green	£6.00	€7.80
S-023-KKA	K	●		Yellow	£6.00	€7.80

Standard 3 Hollow Pin RTD Socket

220°C continuous use.

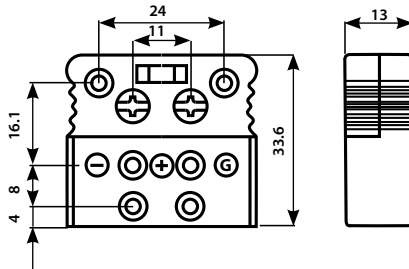

Part No.	Type	Colour	Price Sterling	Price Euro
S-RTD-S	RTD	White	£3.00	€3.90

PLEASE NOTE: all dimensions are subject to change without notice and tolerances apply

High Temperature Ceramic Hollow Pin Socket

500°C continuous use.

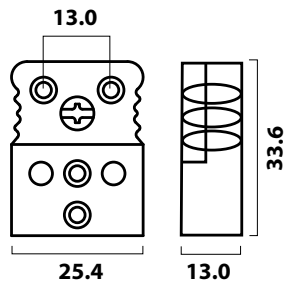

Part No.	T/C	ANSI	IEC	Colour	Price Sterling	Price Euro
S-KSI-C	K		●	Green	£5.50	€7.15
S-KSA-C	K	●		Yellow	£5.50	€7.15
S-NSI-C	N		●	Pink	£5.50	€7.15
S-NSA-C	N	●		Orange	£5.50	€7.15

TTL

Standard Solid Pin Duplex Socket

200°C continuous use.

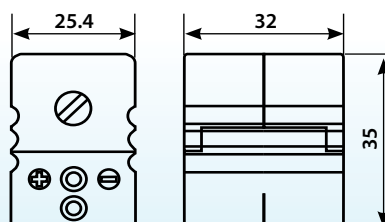

Part No.	T/C	ANSI	IEC	Colour	Price Sterling	Price Euro
422-II-21	K		●	Green	£16.50	€21.45

MINIATURE RANGE - PLUGS/MALE

Mini Plug

200°C continuous use.

Thermo

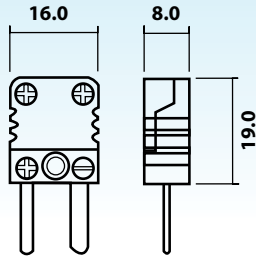

Part No.	T/C	ANSI	IEC	Colour	Price Sterling	Price Euro
S-010-SKI	K		●	Green	£1.90	€2.47
S-010-SKA	K	●		Yellow	£1.90	€2.47
S-010-SJI	J	●	●	Black	£1.90	€2.47
S-010-STI	T		●	Brown	£1.90	€2.47
S-010-SCU	Cu	●	●	White	£1.90	€2.47
S-010-STA	T	●		Blue	£1.90	€2.47
S-010-SNI	N		●	Pink	£1.90	€2.47
S-010-SRI	R		●	Orange	£1.90	€2.47

High Temperature Mini Plug

350°C continuous use.

Thermo

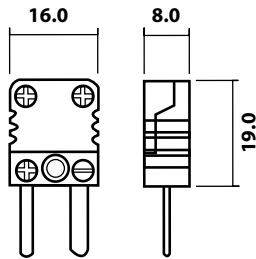

Part No.	T/C	ANSI	IEC	Colour	Price Sterling	Price Euro
S-015-SKI	K		●	Brown	£2.50	€3.25
S-015-SNI	N		●	Brown	£2.50	€3.25

Low Cost Mini Plug

220°C continuous use.

TTL

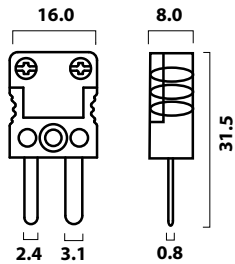

Part No.	T/C	ANSI	IEC	Colour	Price Sterling	Price Euros
M-KPI	K		●	Green	£1.35	€1.78
M-KPA	K	●		Yellow	£1.35	€1.78
M-JP	J	●	●	Black	£1.35	€1.78
M-TPI	T		●	Brown	£1.35	€1.78
M-TPA	T	●		Blue	£1.35	€1.78
M-NPI	N		●	Pink	£1.35	€1.78
M-NPA	N	●		Orange	£1.35	€1.78

COLOUR GUIDE

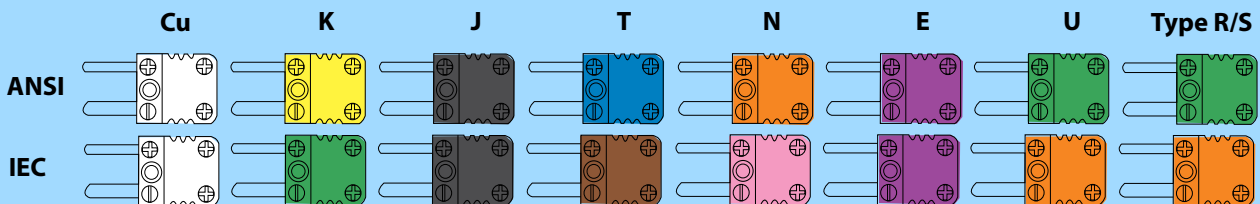

Connector Colour Guide



Contact our Sales Team for assistance.

Tel: +44(0)118 9730739 Fax: +44(0)118 9737222

We welcome your enquiries for any product not listed.

MINIATURE RANGE - PLUGS/MALE

Mini Ceramic Plug

500°C continuous use.

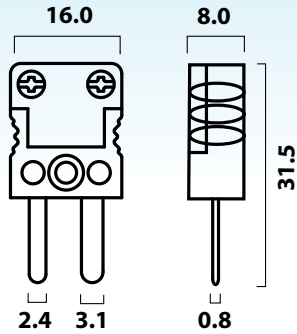

Part No.	T/C	ANSI	IEC	Colour	Price Sterling	Price Euro
M-KPI-C	K		●	White	£3.50	€4.55
M-KPA-C	K	●		White	£3.50	€4.55
M-NPI-C	N		●	White	£3.50	€4.55

Mini 3 pin Thermocouple Plug

200°C continuous use.

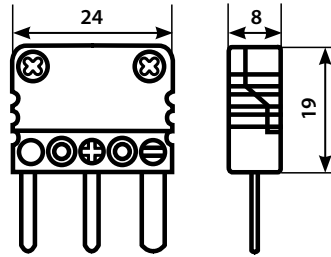

Part No.	T/C	ANSI	IEC	Colour	Price Sterling	Price Euro
S-013-SKI	K		●	Green	£6.50	€8.45
S-013-SKA	K	●		Yellow	£6.50	€8.45

Mini 3 Pin RTD Plug

220°C continuous use.

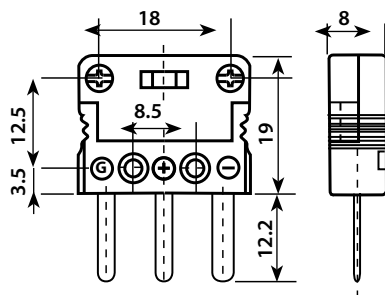

Part No.	Type	Colour	Price Sterling	Price Euro
M-RTD-P	RTD	White	£1.75	€2.28

PLEASE NOTE: all dimensions are subject to change without notice and tolerances apply

Mini Duplex Plug

200°C continuous use.

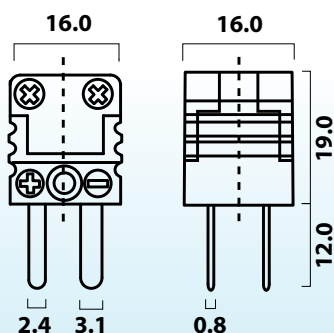

Part No.	T/C	ANSI	IEC	Colour	Price Sterling	Price Euro
411-II-21	K		●		£12.00	€15.60

Please Note: All list prices are subject to change. Check website www.temperaturetechnology.com for up to date information

MINIATURE RANGE - SOCKETS/FEMALE

Mini Socket

200°C continuous use.

Thermo

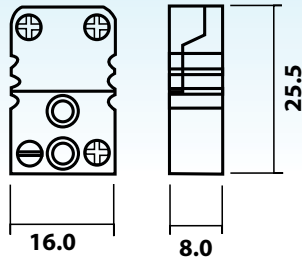

Part No.	T/C	ANSI	IEC	Colour	Price Sterling	Price Euro
S-010-KKI	K		●	Green	£1.90	€2.47
S-010-KKA	K	●		Yellow	£1.90	€2.47
S-010-KJI	J	●	●	Black	£1.90	€2.47
S-010-KTI	T		●	Brown	£1.90	€2.47
S-101-KCU	Cu	●	●	White	£1.90	€2.47
S-010-KTA	T	●		Blue	£1.90	€2.47
S-010-KNI	N		●	Pink	£1.90	€2.47
S-010-KRI	R		●	Orange	£1.90	€2.47

High Temperature Mini Socket

350°C continuous use.

Thermo

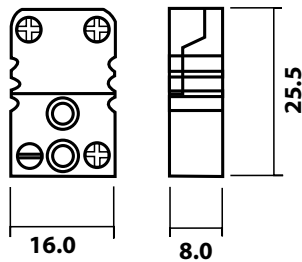

Part No.	T/C	ANSI	IEC	Colour	Price Sterling	Price Euro
S-015-KKI	K		●	Brown	£3.50	€4.55
S-015-KNI	N		●	Brown	£3.50	€4.55

Low Cost Mini Socket

220°C continuous use.

TTL

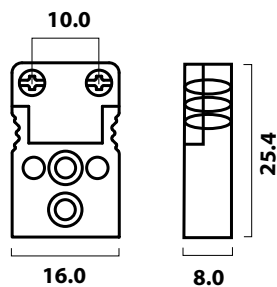

Part No.	T/C	ANSI	IEC	Colour	Price Sterling	Price Euros
M-KSI	K		●	Green	£1.35	€1.76
M-KSA	K	●		Yellow	£1.35	€1.76
M-JS	J	●	●	Black	£1.35	€1.76
M-TSA	T	●		Blue	£1.35	€1.76
M-TSI	T		●	Brown	£1.35	€1.76
M-NSA	N	●		Orange	£1.35	€1.76
M-NS	N		●	Pink	£1.35	€1.76

MICRO CONNECTORS

MICRO CONNECTORS AND OTHER PRODUCTS ARE AVAILABLE CONTACT TTL FOR PRICING & AVAILABILITY.

SALES@TEMPERATURETECHNOLOGY.COM
+44 (0) 1189 730 739

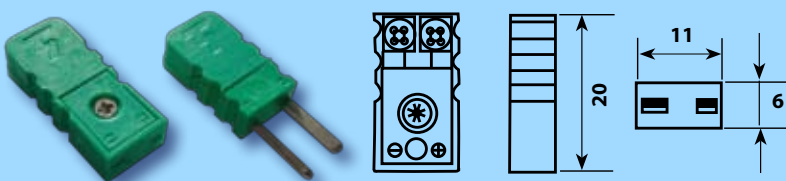

MINIATURE RANGE - SOCKETS/FEMALE

Mini Ceramic Socket

500°C continuous use.

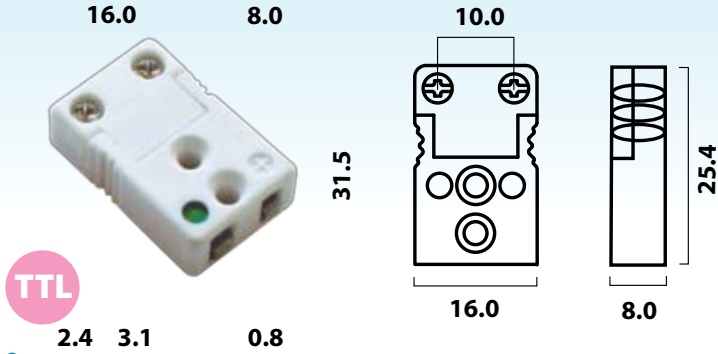

TTL

Part No.	T/C	ANSI	IEC	Colour	Price Sterling	Price Euro
M-KSI-C	K		●	White	£3.50	€4.55
M-KSA-C	K	●		White	£3.50	€4.55
M-NSI-C	N		●	White	£3.50	€4.55

Mini 3 Pin Thermocouple Socket

200°C continuous use.

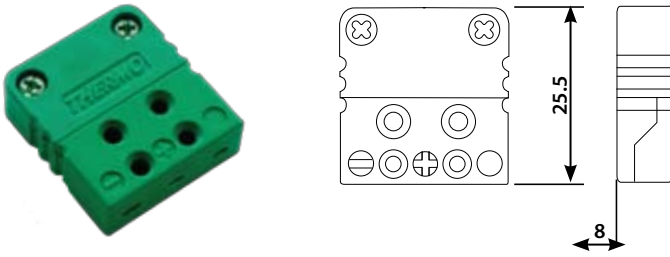

Part No.	T/C	ANSI	IEC	Colour	Price Sterling	Price Euro
S-013-KKI	K		●	Green	£6.50	€8.45
S-013-KKA	K	●		Yellow	£6.50	€8.45

Mini 3 Pin RTD Socket

220°C continuous use.

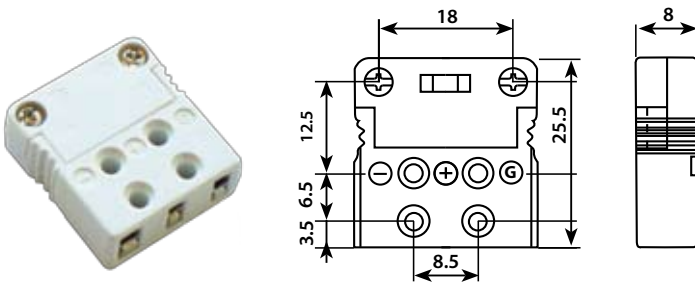

Part No.	Type	Colour	Price Sterling	Price Euro
M-RTD-S	RTD	White	£1.75	€2.28

Check out our website for latest prices
& regular updates:
www.temperaturetechnology.com

Mini Duplex Socket

200°C continuous use.

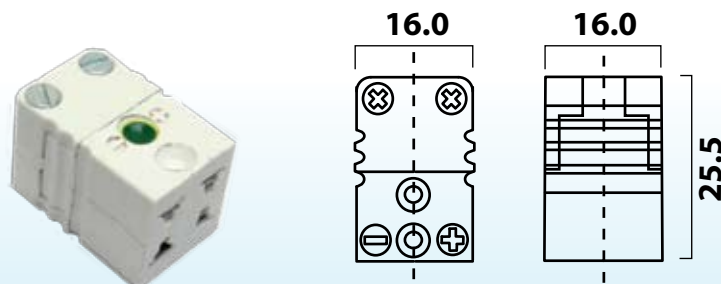

Part No.	T/C	ANSI	IEC	Colour	Price Sterling	Price Euro
412-II-21	K		●	Green	£12.00	€15.60

Please Note: All list prices are subject to change.
Check website www.temperaturetechnology.com for up to date information

PANEL SOCKETS

Mini Circular Panel Socket

200°C continuous use.

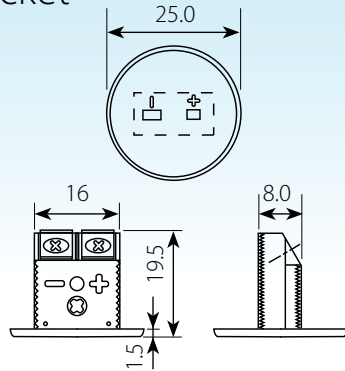
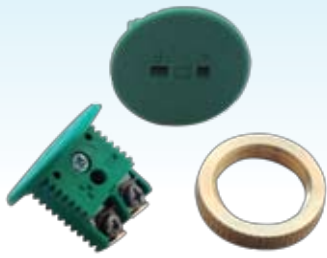

Part No.	T/C	ANSI	IEC	Colour	Price Sterling	Price Euros
S-240-KKI	K		●	Green	£3.50	€4.55
S-240-KTI	T		●	Brown	£3.50	€4.55
S-240-KJI	J	●	●	Black	£3.50	€4.55
S-240-KRI	R/S		●	Orange	£3.50	€4.55
S-195*	Brass lock nut for mini panel socket				£3.50	€4.55

Standard Panel Socket

200°C continuous use.

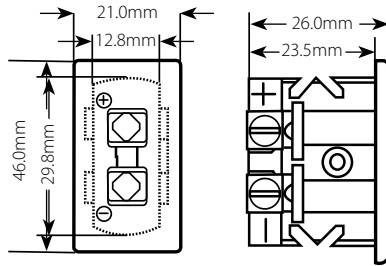

Part No.	Description	Price Sterling	Price Euro
S-245-KKI	Std K Panel Socket	£6.00	€7.80
S-290	Mounting Kit for 245-KKI	£1.00	€1.30

Standard Panel Multiple Measuring Circuit



Part No.	Description	T/C Type	ANSI	IEC	Price Sterling	Price Euro
S-200-S-01-KI	Panel 1 Circuit	K		●	£15.00	€19.50
S-200-S-06-KI	Panel 6 Circuits	K		●	£73.00	€94.90
S-200-S-12-KI	Panel 12 Circuits	K		●	£155.00	€201.50

6 panel circuit illustration

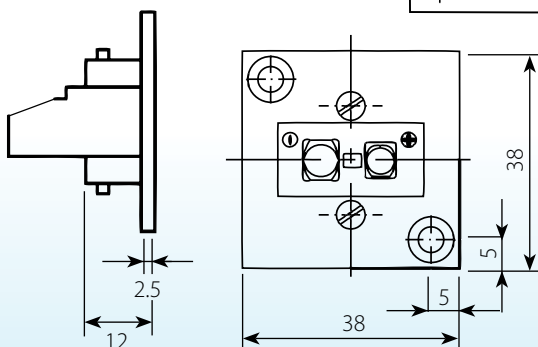
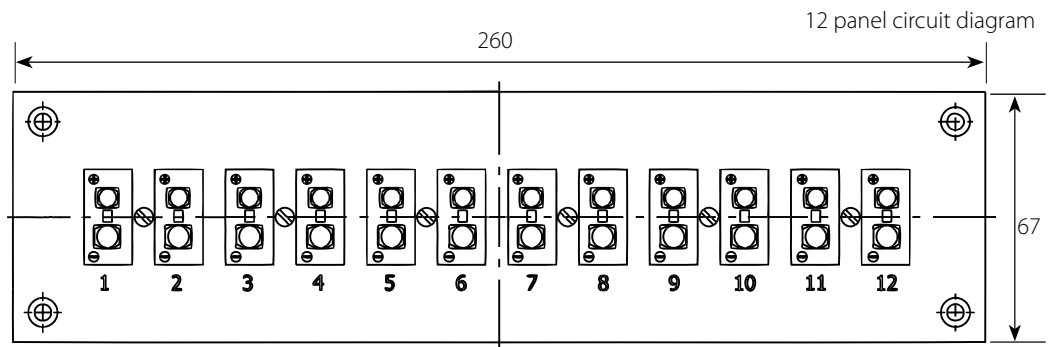

1 panel circuit diagram

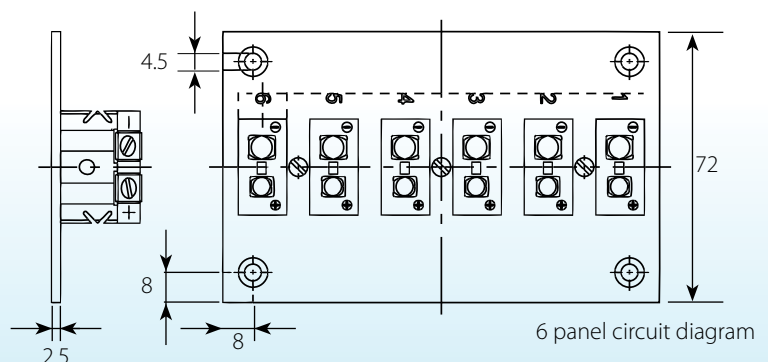

6 panel circuit diagram

CONNECTOR ACCESSORIES

Cable Clamps

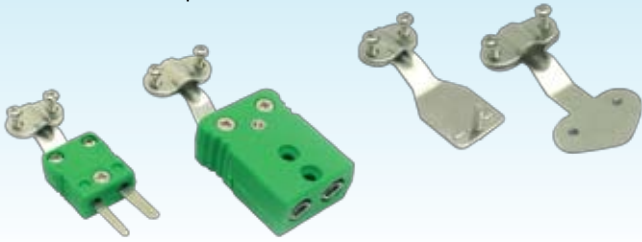

Part No.	To Suit Connector	Price Sterling	Price Euros
M-CC		£0.75	€0.98
S-CC		£0.95	€1.24
S-090-M		£0.95	€1.24
S-090-S		£1.45	€1.89

Standard Brass Inserts (Square Base)

To suit



Part No.	ID	Price Sterling	Price Euro
S-BITS-17	1.7mm	£0.40	€0.52
S-BITS-21	2.1mm	£0.40	€0.52
S-BITS-31	3.1mm	£0.40	€0.52
S-BITS-46	4.6mm	£0.40	€0.52
S-BITS-49	4.9mm	£0.40	€0.52
S-BITS-61	6.1mm	£0.40	€0.52
S-BITS-S*	N/A	£0.40	€0.52

*Solid (no bore) can be drilled to suit 0.5mm and 1mm cables.

Standard Brass Inserts (Hex base)

To suit



Part No.	ID	Price Sterling	Price Euros
S-BI-17	1.7mm	£0.35	€0.46
S-BI-21	2.1mm	£0.35	€0.46
S-BI-31	3.1mm	£0.35	€0.46
S-BI-46	4.6mm	£0.35	€0.46
S-BI-49	4.9mm	£0.35	€0.46
S-BI-61	6.1mm	£0.35	€0.46
S-BI-S*	n/a	£0.35	€0.46

*Solid (no bore) can be drilled to suit 0.5mm and 1mm cables.

Mini Brass Inserts (Hex Base)

To suit &



Part No.	ID	Price Sterling	Price Euros
M-BI-17	1.7mm	£0.25	€0.36
M-BI-21	2.1mm	£0.25	€0.36
M-BI-31	3.1mm	£0.25	€0.36
M-BI-S*	n/a	£0.25	€0.36

*Solid (no bore) can be drilled to suit 0.5mm and 1mm cables.

Neoprenes

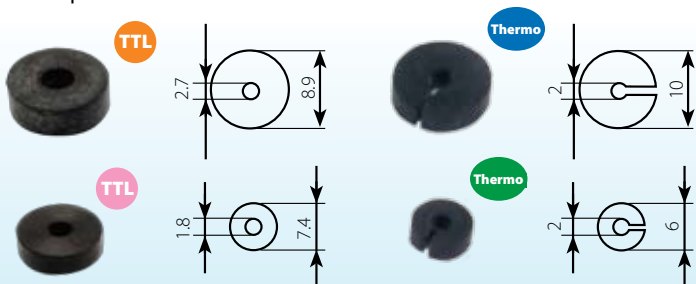

Part No.	To suit Connector	Price Sterling	Price Euro
M-N		£0.09	€0.12
S-N		£0.10	€0.13
S-092-M		£0.09	€0.12
S-092-S		£0.10	€0.13